

Silicon N-Channel MOSFET Triode

- For high-frequency stages up to 300 MHz preferably in FM applications

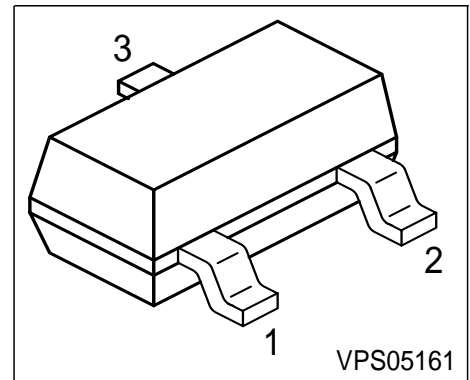

ESD: Electrostatic discharge sensitive device, observe handling precaution!

Type	Marking	Pin Configuration			Package
BF999	LDs	1 = G	2 = D	3 = S	SOT23

Maximum Ratings

Parameter	Symbol	Value	Unit
Drain-source voltage	V_{DS}	20	V
Drain current	I_D	30	mA
Gate-source peak current	$\pm I_{GSM}$	10	mA
Total power dissipation, $T_S \leq 76 \text{ }^\circ\text{C}$	P_{tot}	200	mW
Storage temperature	T_{stg}	-55 ... 150	°C
Channel temperature	T_{ch}	150	

Thermal Resistance

Channel - soldering point ¹⁾	R_{thchs}	≤ 370	K/W
---	-------------	------------	-----

¹For calculation of R_{thJA} please refer to Application Note Thermal Resistance

Electrical Characteristics at $T_A = 25\text{ }^\circ\text{C}$, unless otherwise specified.

Parameter	Symbol	Values			Unit
		min.	typ.	max.	
DC characteristics					
Drain-source breakdown voltage $I_D = 10\text{ }\mu\text{A}$, $-V_{GS} = 4\text{ V}$	$V_{(BR)DS}$	20	-	-	V
Gate-source breakdown voltage $\pm I_{GS} = 10\text{ mA}$, $V_{DS} = 0$	$\pm V_{(BR)GSS}$	6.5	-	12	
Gate-source leakage current $\pm V_{GS} = 5\text{ V}$, $V_{DS} = 0$	$\pm I_{GSS}$	-	-	50	nA
Drain current $V_{DS} = 10\text{ V}$, $V_{GS} = 0$	I_{DSS}	5	-	18	mA
Gate-source pinch-off voltage $V_{DS} = 10\text{ V}$, $I_D = 20\text{ }\mu\text{A}$	$-V_{GS(p)}$	-	-	2.5	V
AC characteristics					
Forward tranconductance $V_{DS} = 10\text{ V}$, $I_D = 10\text{ mA}$	g_{fs}	14	16	-	mS
Gate input capacitance $V_{DS} = 10\text{ V}$, $I_D = 10\text{ mA}$, $f = 1\text{ MHz}$	C_{gss}	-	2.5	-	pF
Reverse tranfer capacitance $V_{DS} = 10\text{ V}$, $I_D = 10\text{ mA}$, $f = 1\text{ MHz}$	C_{dg}	-	25	-	fF
Output capacitance $V_{DS} = 10\text{ V}$, $I_D = 10\text{ mA}$, $f = 1\text{ MHz}$	C_{dss}	-	1	-	pF
Power gain $V_{DS} = 10\text{ V}$, $I_D = 10\text{ mA}$, $f = 200\text{ MHz}$	G_p	-	25	-	dB
Noise figure $V_{DS} = 10\text{ V}$, $I_D = 10\text{ mA}$, $f = 200\text{ MHz}$	F	-	1	-	

Total power dissipation $P_{tot} = f(T_S)$

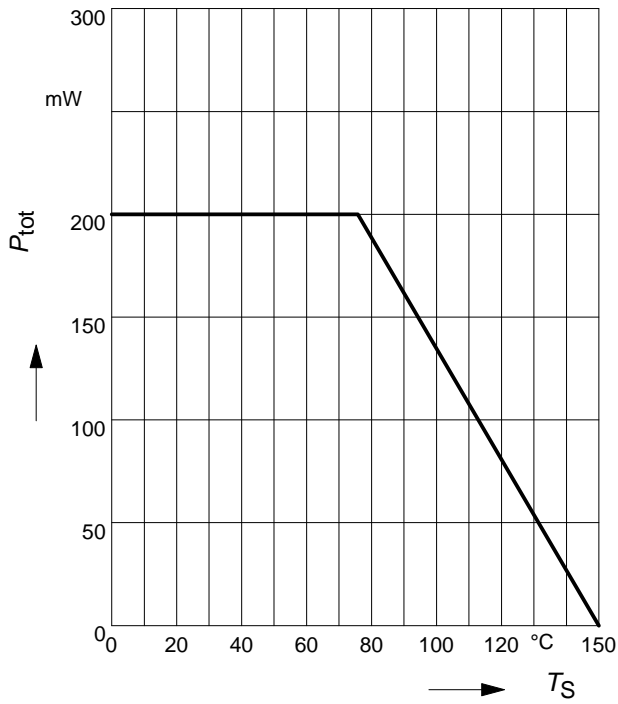

Output characteristics $I_D = f(V_{DS})$

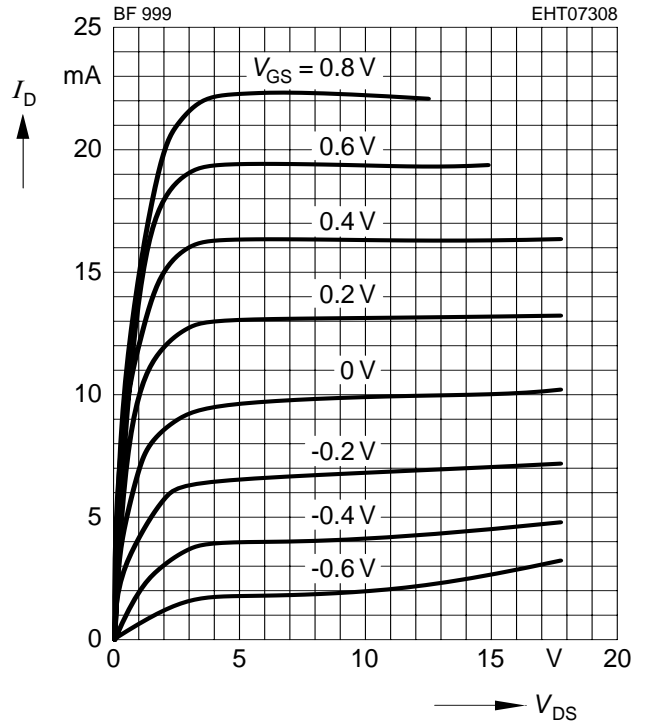

Gate transconductance $g_{fs} = f(V_{GS})$

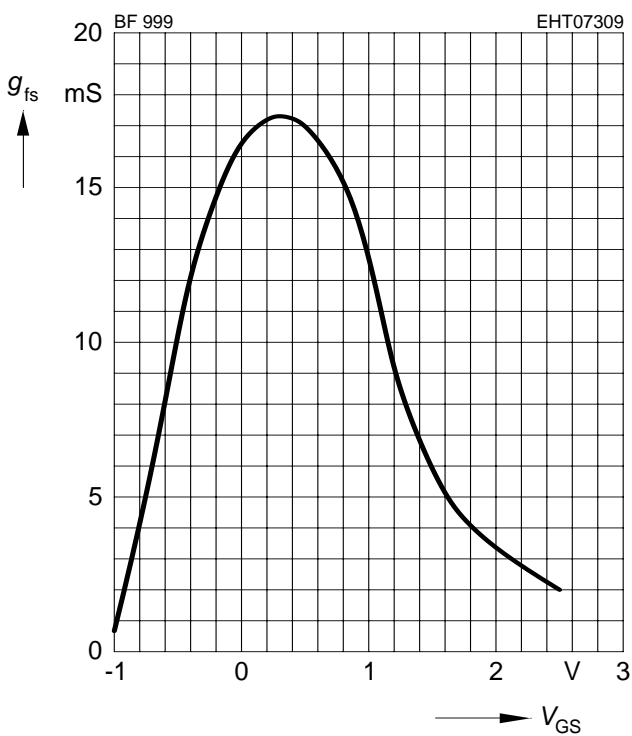

Drain current $I_D = f(V_{GS})$

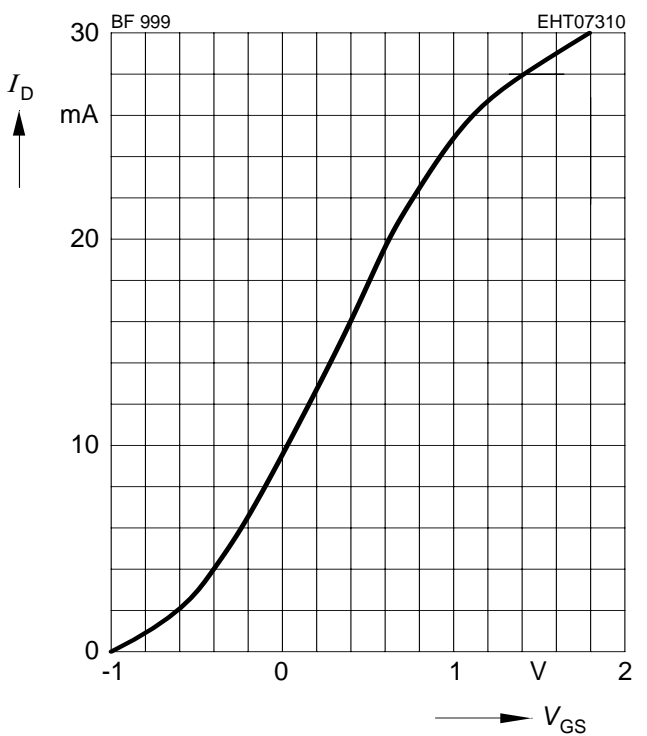

Gate input capacitance $C_{gss} = f(V_{GS})$

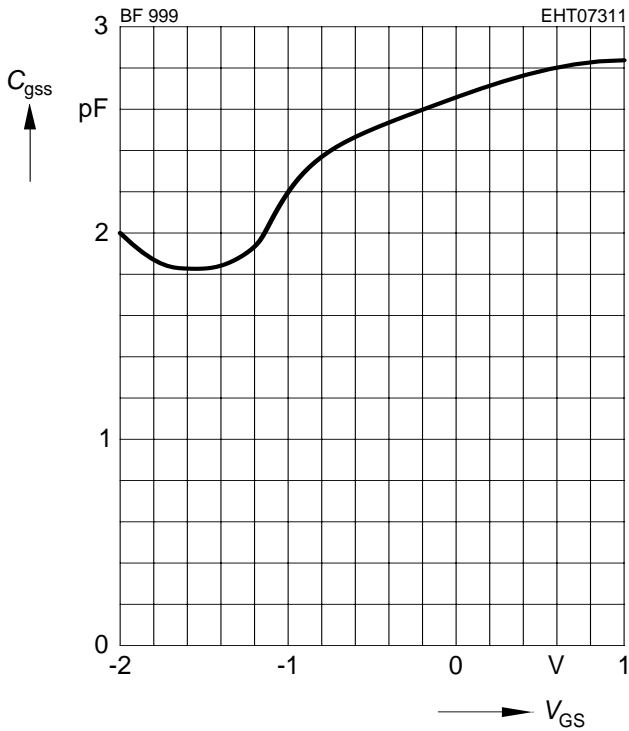

Output capacitance $C_{dss} = f(V_{DS})$

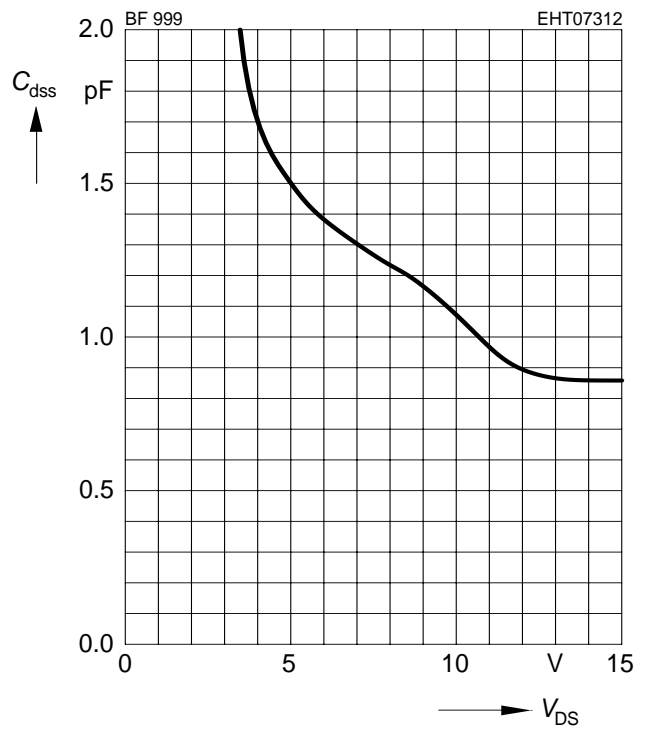

Reverse transfer capacitance

$C_{dg} = f(V_{DS})$

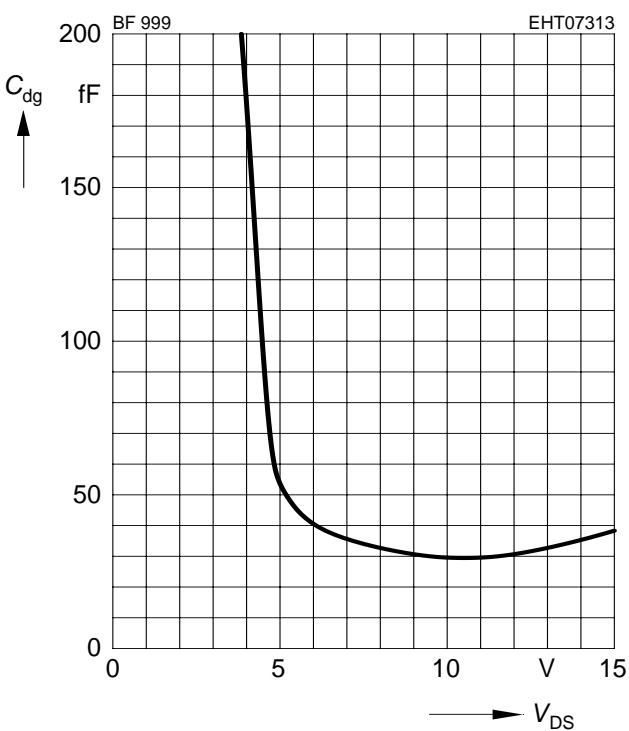

Gate input admittance y_{11s}

(common-source)

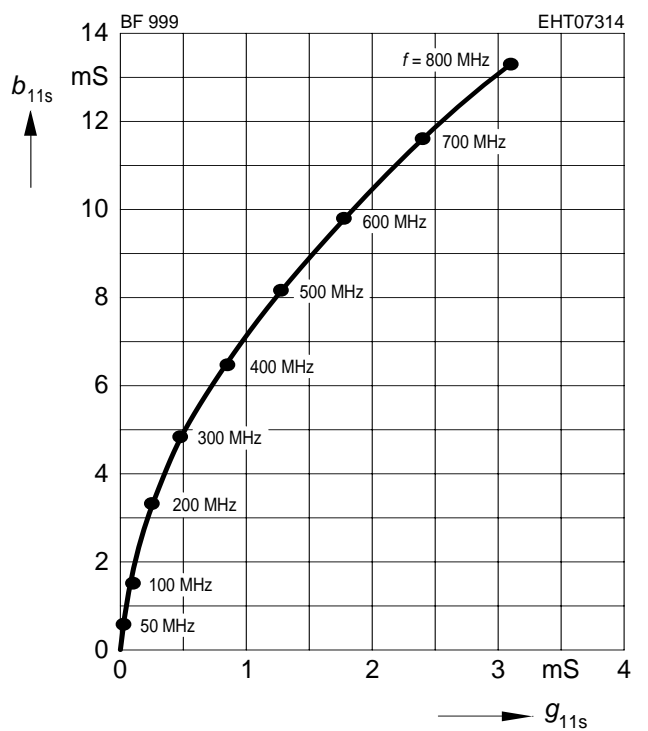

Gate forward transfer admittance y_{21s}
(common-source)

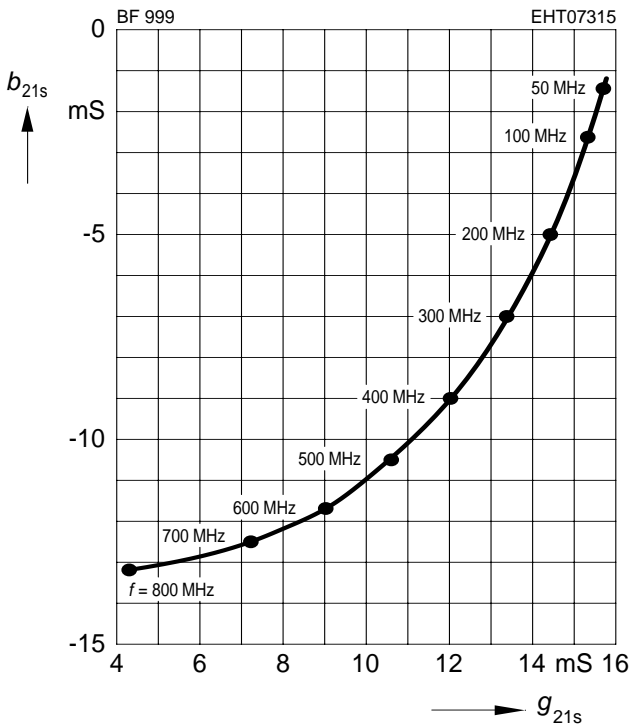

Output admittance y_{22s}
(common-source)

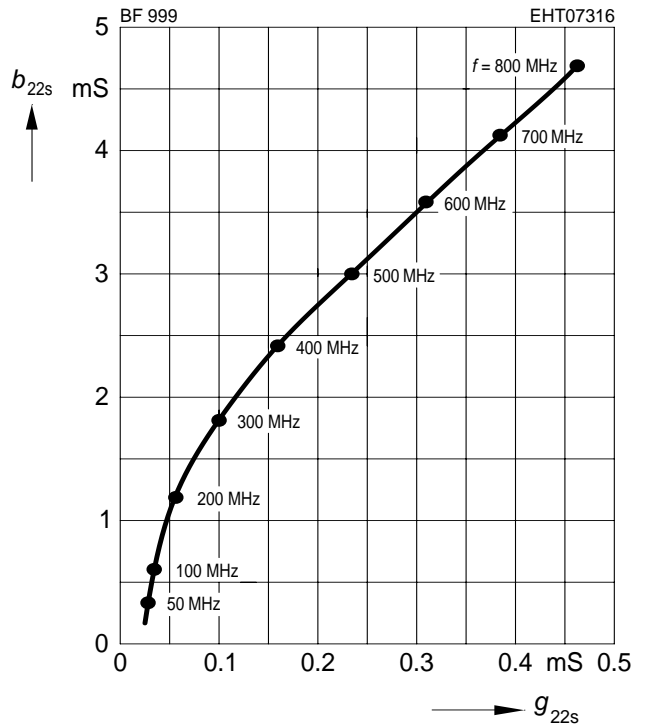

Test circuit for power gain and noise figure
 $f = 200$ MHz

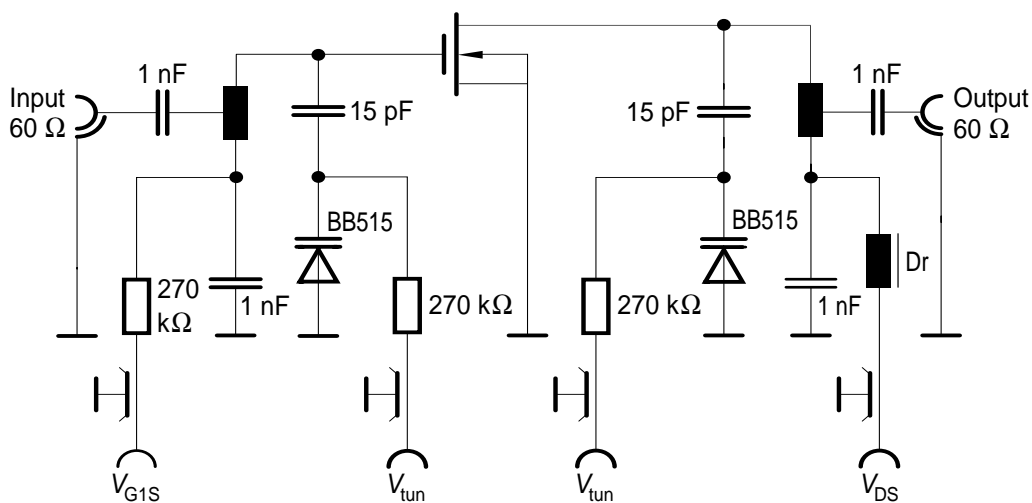

EHM07024