

KESIT A-A

DIKKAT: BU RESİM VE ÜRÜN ÖNCEDEN HABER VERİLMEKSİZİN DEĞİŞTİREBİLİR. RESİM ÇİZİLMİŞ HATASIZ OLMASINA ÇALIŞILMASINA RAĞMEN RESİMDE HATALAR BULUNABİLİR. RESİMDEKİ HATALARDAN DOLAYI OLUŞABİLECEK ZARARLAR İÇİN ALTINKAYA HIÇ BİR SORUMLULUK KABUL ETMEZ. BÜTÜN ÖLÇÜLER KULLANILMADAN ÖNCE ÜRETİLMİŞ GERÇEK NÜMUNEDEN KONTROL EDİLMELİDİR.

PROPRIETARY AND CONFIDENTIAL THE INFORMATION CONTAINED IN THIS DRAWING IS THE SOLE PROPERTY OF ALTINKAYA ENCLOSURES. ANY REPRODUCTION IN PART OR AS A WHOLE WITHOUT THE WRITTEN PERMISSION OF ALTINKAYA ENCLOSURES IS PROHIBITED.		ARTICLE NO:	REVISION:
DRAWN: Dursun Daşdemir CHECKED: Ali Altınışık		 ENCLOSURES FOR ELECTRONICS	CONTACT: <a href="http://www.altinkaya.com.tr">www.altinkaya.com.tr</a>
COMMENTS: This drawing is subject to technical modification without prior notice. Typographical and other errors do not justify any claims for damages. All dimensions should be verified using an actual produced part.		TITLE: <b>Masa Tipi Alüminyum Laboratuvar Kutusu</b>	
MATERIAL:		DWG NO: <b>DT-550-0-0-A-0</b>	A3
WEIGHT:		SCALE:1:2	SHEET 1 OF 1

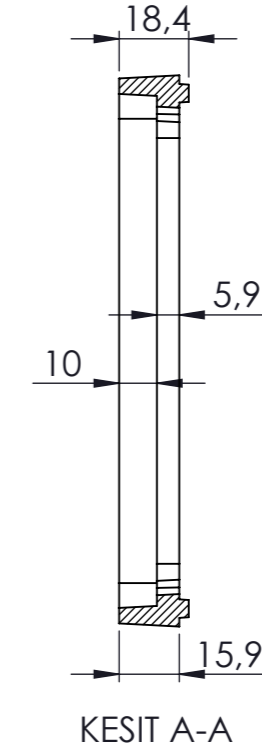

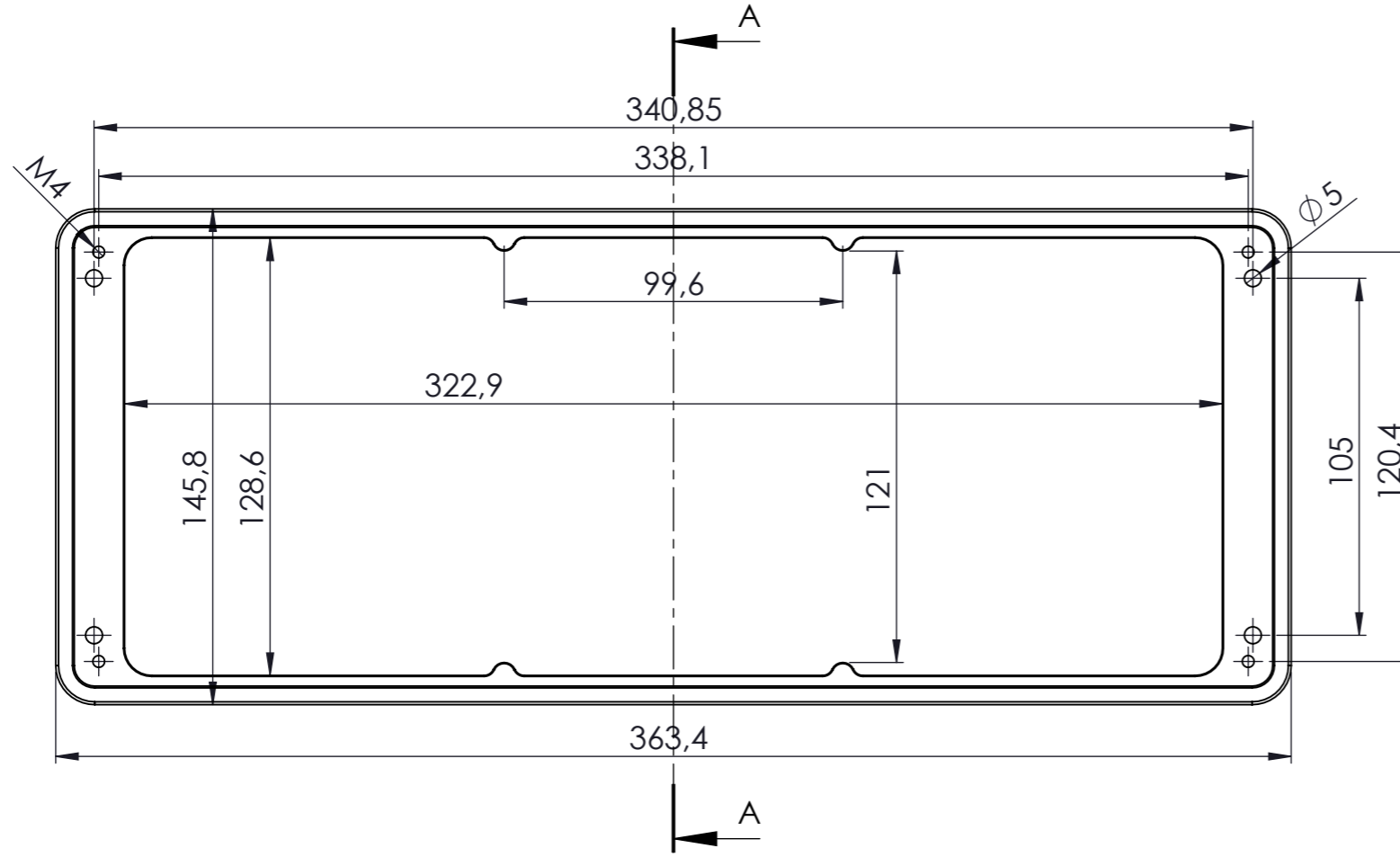

DIKKAT: BU RESİM VE ÜRÜN ÖNCEDEN HABER VERİLMEKSİZİN DEĞİŞTİREBİLİR. RESİM ÇİZİLİRKEN HATASIZ OLMASINA ÇALIŞILMASINA RAĞMEN RESİMDE HATALAR BULUNABİLİR. RESİMDEKİ HATALARDAN DOLAYI OLUŞABİLECEK ZARARLAR İÇİN ALTINKAYA HIÇ BİR SORUMLULUK KABUL ETMEZ. BÜTÜN ÖLÇÜLER KULLANILMADAN ÖNCE ÜRETİLMİŞ GERÇEK NÜMUNEDEN KONTROL EDİLMELİDİR.

PROPRIETARY AND CONFIDENTIAL THE INFORMATION CONTAINED IN THIS DRAWING IS THE SOLE PROPERTY OF ALTINKAYA ENCLOSURES. ANY REPRODUCTION IN PART OR AS A WHOLE WITHOUT THE WRITTEN PERMISSION OF ALTINKAYA ENCLOSURES IS PROHIBITED.		ARTICLE NO:	REVISION:
DRAWN: Dursun Daşdemir CHECKED: Ali Altınışık		 CONTACT: <a href="http://www.altinkaya.com.tr">www.altinkaya.com.tr</a>	TITLE:
COMMENTS: This drawing is subject to technical modification without prior notice. Typographical and other errors do not justify any claims for damages. All dimensions should be verified using an actual produced part.		<h2>Ön Çerçeve</h2>	
MATERIAL:		DWG NO: <b>DT-550-P-1</b>	A3
WEIGHT:		SCALE: 1:2	SHEET 1 OF 1

Ön Panel

133,70

351

A

A

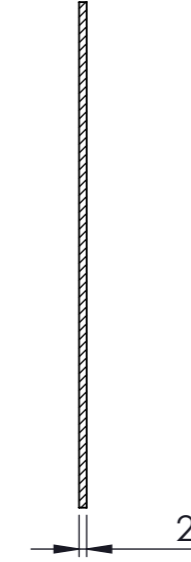

KESIT A-A

Arka Panel

133,70

351

A

A

3

6

22

15,25

DIKKAT: BU RESİM VE ÜRÜN ÖNCEDEN HABER VERİLMEKSİZİN DEĞİŞTİREBİLİR. RESİM ÇİZİLİRKEN HATASIZ OLMASINA ÇALIŞILMASINA RAĞMEN RESİMDE HATALAR BULUNABİLİR. RESİMDEKİ HATALARDAN DOLAYI OLUŞABİLECEK ZARARLAR İÇİN ALTINKAYA HIÇ BİR SORUMLULUK KABUL ETMEZ. BÜTÜN ÖLÇÜLER KULLANILMADAN ÖNCE ÜRETİLMİŞ GERÇEK NÜMUNEDEN KONTROL EDİLMELİDİR.

PROPRIETARY AND CONFIDENTIAL. THE INFORMATION CONTAINED IN THIS DRAWING IS THE SOLE PROPERTY OF ALTINKAYA ENCLOSURES. ANY REPRODUCTION IN PART OR AS A WHOLE WITHOUT THE WRITTEN PERMISSION OF ALTINKAYA ENCLOSURES IS PROHIBITED.

ARTICLE NO:

REVISION:



CONTACT: [www.altinkaya.com.tr](http://www.altinkaya.com.tr)

DRAWN Dursun Daşdemir

CHECKED Ali Altınışık

TITLE:

DT-550  
Ön ve Arka Panel

COMMENTS: This drawing is subject to technical modification without prior notice. Typographical and other errors do not justify any claims for damages. All dimensions should be verified using an actual produced part.

MATERIAL:

DWG NO:

DT-550-P-4

A3

WEIGHT:

SCALE:1:2

SHEET 1 OF 1



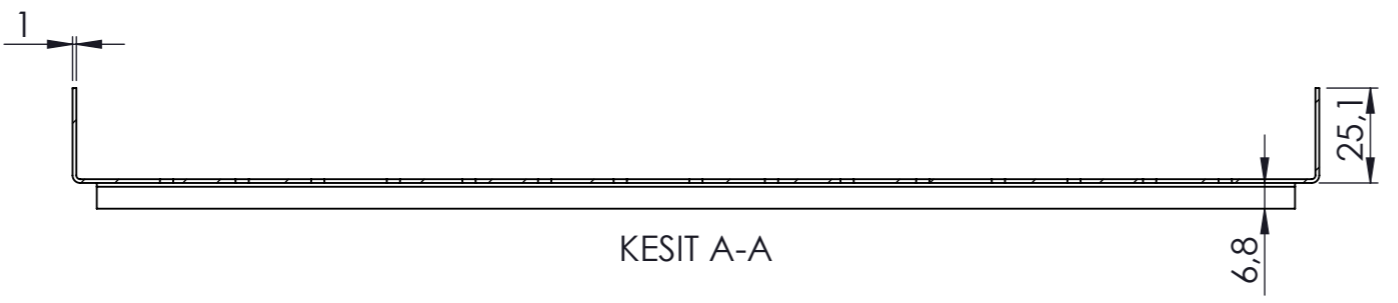
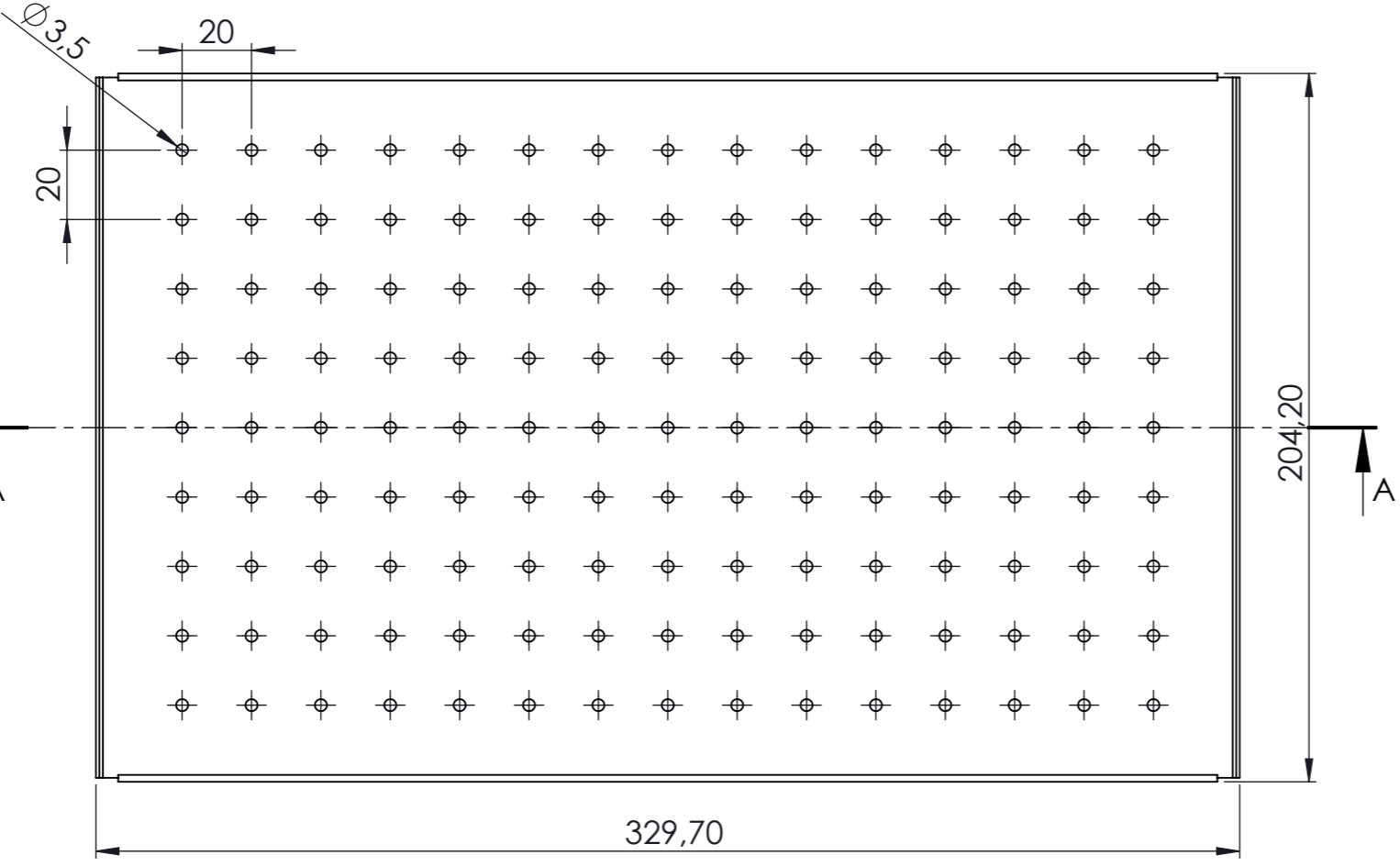
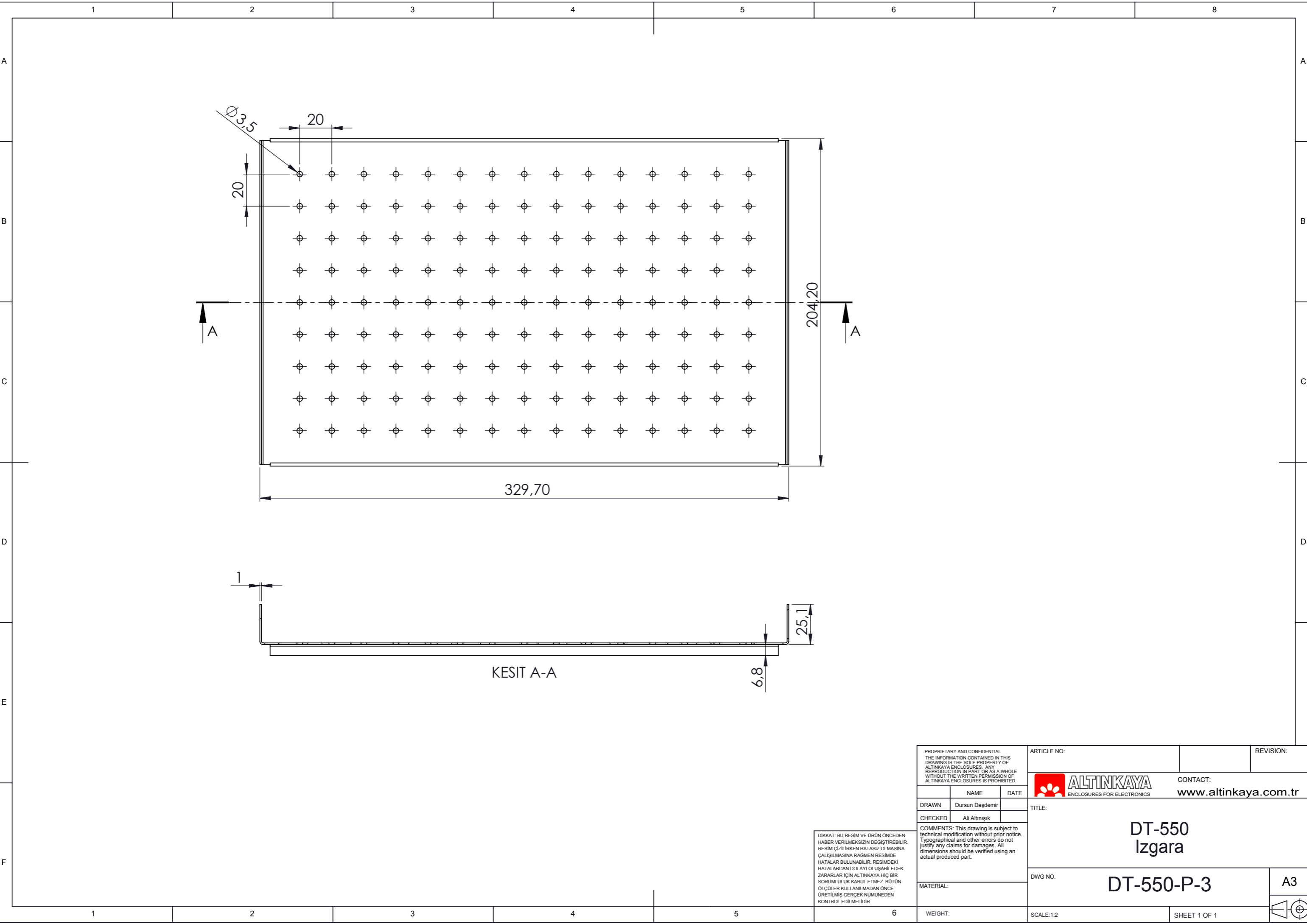

KESIT A-A

DIKKAT: BU RESİM VE ÜRÜN ÖNCEDEN HABER VERİLMEKSİZİN DEĞİŞTİREBİLİR. RESİM ÇİZİLMİŞ HATASIZ OLMASINA ÇALIŞILMASINA RAĞMEN RESİMDEKİ HATALAR BULUNABİLİR. RESİMDEKİ HATALARDAN DOLAYI OLUŞABİLECEK ZARARLAR İÇİN ALTINKAYA HiÇ BİR SORUMLULUK KABUL ETMEZ. BÜTÜN ÖLÇÜLER KULLANILMADAN ÖNCE ÜRETİLMİŞ GERÇEK NÜMUNEDEN KONTROL EDİLMELİDİR.

PROPRIETARY AND CONFIDENTIAL. THE INFORMATION CONTAINED IN THIS DRAWING IS THE SOLE PROPERTY OF ALTINKAYA ENCLOSURES. ANY REPRODUCTION IN PART OR AS A WHOLE WITHOUT THE WRITTEN PERMISSION OF ALTINKAYA ENCLOSURES IS PROHIBITED.		ARTICLE NO:	REVISION:
DRAWN: Dursun Daşdemir		CONTACT: <a href="http://www.altinkaya.com.tr">www.altinkaya.com.tr</a>	
CHECKED: Ali Altınışık		TITLE: DT-550 Izgara	
MATERIAL:		DWG NO: DT-550-P-3	A3
WEIGHT:		SCALE: 1:2	SHEET 1 OF 1



CONTACT: [www.altinkaya.com.tr](http://www.altinkaya.com.tr)

TITLE: DT-550 Izgara

DWG NO: DT-550-P-3 A3

SCALE: 1:2 SHEET 1 OF 1