

AVAILABLE IN
8-PIN SO PACKAGE

MAXIM

8th-Order, Lowpass, Switched-Capacitor Filters

General Description

The MAX291/MAX292/MAX295/MAX296 are easy-to-use, 8th-order, lowpass, switched-capacitor filters that can be set up with corner frequencies from 0.1Hz to 25kHz (MAX291/MAX292) or 0.1Hz to 50kHz (MAX295/MAX296).

The MAX291/MAX295 Butterworth filters provide maximally flat passband response, and the MAX292/MAX296 Bessel filters provide low overshoot and fast settling. All four filters have fixed responses, so the design task is limited to selecting the clock frequency that controls the filter's corner frequency.

An external capacitor is used to generate a clock using the internal oscillator, or an external clock signal can be used. An uncommitted operational amplifier (noninverting input grounded) is provided for building a continuous-time lowpass filter for post-filtering or anti-aliasing.

Produced in an 8-pin DIP/SO and a 16-pin wide SO package, and requiring a minimum of external components, the MAX291 series delivers very aggressive performance from a tiny area.

Applications

ADC Anti-Aliasing Filter
Noise Analysis
DAC Post-Filtering
50Hz/60Hz Line-Noise Filtering

Typical Operating Circuit

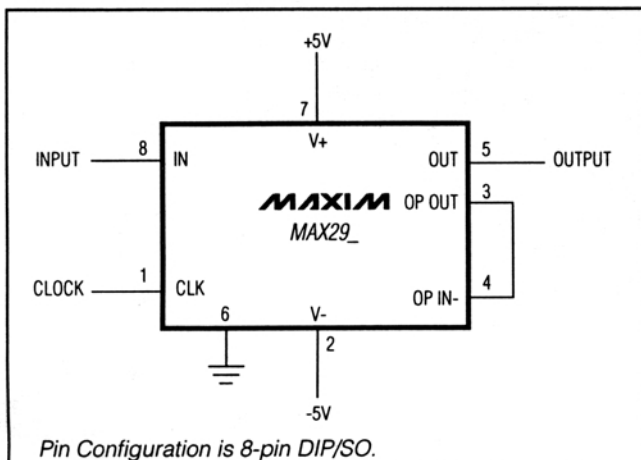

Features

- ◆ 8th-Order Lowpass Filters:
 - Butterworth (MAX291/MAX295)
 - Bessel (MAX292/MAX296)
- ◆ Clock-Tunable Corner-Frequency Range:
 - 0.1Hz to 25kHz (MAX291/MAX292)
 - 0.1Hz to 50kHz (MAX295/MAX296)
- ◆ No External Resistors or Capacitors Required
- ◆ Internal or External Clock
- ◆ Clock to Corner-Frequency Ratio:
 - 100:1 (MAX291/MAX292)
 - 50:1 (MAX295/MAX296)
- ◆ Low Noise: -70dB THD + Noise (Typ)
- ◆ Operate with a Single +5V Supply or Dual $\pm 5V$ Supplies
- ◆ Uncommitted Op Amp for Anti-Aliasing or Clock-Noise Filtering
- ◆ 8-Pin DIP and SO Packages

Ordering Information

PART	TEMP. RANGE	PIN-PACKAGE
MAX291CPA	0°C to +70°C	8 Plastic DIP
MAX291CSA	0°C to +70°C	8 SO
MAX291CWE	0°C to +70°C	16 Wide SO
MAX291C/D	0°C to +70°C	Dice*
MAX291EPA	-40°C to +85°C	8 Plastic DIP
MAX291ESA	-40°C to +85°C	8 SO
MAX291EWE	-40°C to +85°C	16 Wide SO
MAX291MJA	-55°C to +125°C	8 CERDIP**

Ordering Information continued on last page.

* Contact factory for dice specifications.

** Contact factory for availability and processing to MIL-STD-883.

Pin Configurations

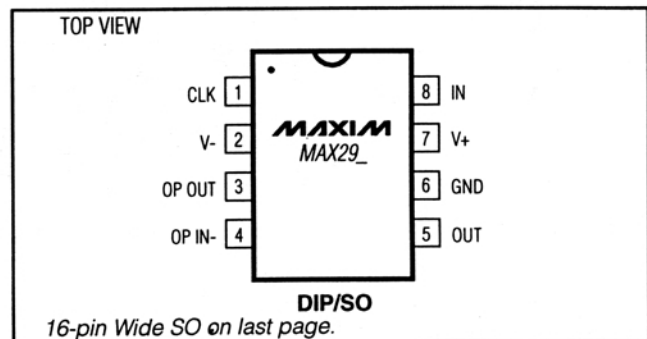

MAX291/MAX292/MAX295/MAX296

8th-Order, Lowpass, Switched-Capacitor Filters

ABSOLUTE MAXIMUM RATINGS

Supply Voltage (V+ to V-).....12V
 Input Voltage at Any Pin.....V- + (-0.3V) ≤ V_{IN} ≤ V+ + (0.3V)
 Continuous Power Dissipation
 8-Pin Plastic DIP (derate 9.09mW/°C above +70°C) ...727mW
 8-Pin SO (derate 5.88mW/°C above +70°C).....471mW
 16-Pin Wide SO (derate 9.52mW/°C above +70°C)762mW
 8-Pin CERDIP (derate 8.00mW/°C above +70°C).....640mW

Operating Temperature Ranges

MAX29_C_.....0°C to +70°C
 MAX29_E_.....-40°C to +85°C
 MAX29_MJA-55°C to +125°C
 Storage Temperature Range-65°C to +160°C
 Lead Temperature (soldering, 10sec).....+300°C

Stresses beyond those listed under "Absolute Maximum Ratings" may cause permanent damage to the device. These are stress ratings only, and functional operation of the device at these or any other conditions beyond those indicated in the operational sections of the specifications is not implied. Exposure to absolute maximum rating conditions for extended periods may affect device reliability.

ELECTRICAL CHARACTERISTICS

(V+ = 5V, V- = -5V, filter output measured at OUT pin, 20kΩ load resistor to ground at OUT and OP OUT, f_{CLK} = 100kHz (MAX291/MAX292) or f_{CLK} = 50kHz (MAX295/MAX296), T_A = T_{MIN} to T_{MAX}, unless otherwise noted.)

PARAMETER	CONDITIONS		MIN	TYP	MAX	UNITS
FILTER CHARACTERISTICS						
Corner-Frequency Range	MAX291/MAX292			0.1-25k		Hz
	MAX295/MAX296			0.1-50k		
Clock to Corner Frequency Ratio	MAX291/MAX292			100:1		
	MAX295/MAX296			50:1		
Clock to Corner Frequency Tempco	MAX291			10		ppm/°C
	MAX292			40		
	MAX295			5		
	MAX296			60		
Insertion Gain Relative to DC Gain	MAX291	f _{IN} = 0.50 F _O		-0.02	-0.1	dB
		f _{IN} = 1.00 F _O	-2.2	-2.7	-3.2	
		f _{IN} = 2.00 F _O	-43.0	-48.0		
		f _{IN} = 3.00 F _O	-70.0	-76.0		
	MAX292	f _{IN} = 0.25 F _O	-0.1	-0.2	-0.3	
		f _{IN} = 0.50 F _O	-0.6	-0.8	-1.0	
		f _{IN} = 1.00 F _O	-2.7	-3.0	-3.3	
		f _{IN} = 2.00 F _O	-11.0	-13.0	-15.0	
		f _{IN} = 3.00 F _O	-30.0	-34.0		
		f _{IN} = 4.00 F _O	-47.0	-51.0		
	MAX295	f _{IN} = 6.00 F _O	-74.0	-78.0		
		f _{IN} = 0.50 F _O		-0.02	-0.1	
		f _{IN} = 1.00 F _O	-2.2	-2.7	-3.2	
		f _{IN} = 2.00 F _O	-43.0	-48.0		
	MAX296	f _{IN} = 3.00 F _O	-70.0	-76.0		
		f _{IN} = 0.25 F _O	-0.1	-0.2	-0.3	
		f _{IN} = 0.50 F _O	-0.6	-0.8	-1.0	
		f _{IN} = 1.00 F _O	-2.7	-3.0	-3.3	
		f _{IN} = 2.00 F _O	-11.0	-13.0	-15.0	
		f _{IN} = 3.00 F _O	-30.0	-34.0		
f _{IN} = 4.00 F _O		-47.0	-51.0			
f _{IN} = 6.00 F _O		-74.0	-78.0			

8th-Order, Lowpass, Switched-Capacitor Filters

MAX291/MAX292/MAX295/MAX296

ELECTRICAL CHARACTERISTICS (continued)

(V+ = 5V, V- = -5V, filter output measured at OUT pin, 20kΩ load resistor to ground at OUT and OP OUT, fCLK = 100kHz (MAX291/MAX292) or fCLK = 50kHz (MAX295/MAX296), TA = TMIN to TMAX, unless otherwise noted.)

PARAMETER	CONDITIONS	MIN	TYP	MAX	UNITS
Output DC Swing		±4			V
Output Offset Voltage	IN = GND		±150	±400	mV
DC Insertion Gain Error with Output Offset Removed		0.15	0	-0.15	dB
Total Harmonic Distortion plus Noise	TA = +25°C, fCLK = 100kHz		-70		dB
Clock Feedthrough	fCLK = 100kHz		6		mVp-p
CLOCK					
Internal Oscillator Frequency	COSC = 1000pF	29	35	43	kHz
Internal Oscillator Current Source/Sink	VCLK = 0V or 5V		±70	±120	μA
Clock Input (Note 1) High		4.0			V
Low				1.0	V
UNCOMMITTED OP AMP					
Input Offset Voltage			±10	±50	mV
Output DC Swing		±4			V
Input Bias Current			0.05		μA
POWER REQUIREMENTS					
Supply Voltage Dual Supply		±2.375		±5.500	V
Single Supply	V- = 0V, GND = V±2	4.750		11.000	V
Supply Current	V+ = 5V, V- = -5V, VCLK = 0V to 5V		15	22	mA
	V+ = 2.375V, V- = -2.375V, VCLK = -2V to 2V		7	12	

Note 1: Guaranteed by Design.

Typical Operating Characteristics

(V+ = 5V, V- = -5V, TA = +25°C, fCLK = 100kHz (MAX291/MAX292) or fCLK = 50kHz (MAX295/MAX296), unless otherwise noted.)

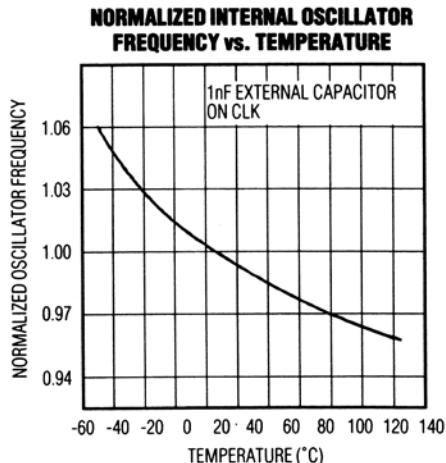
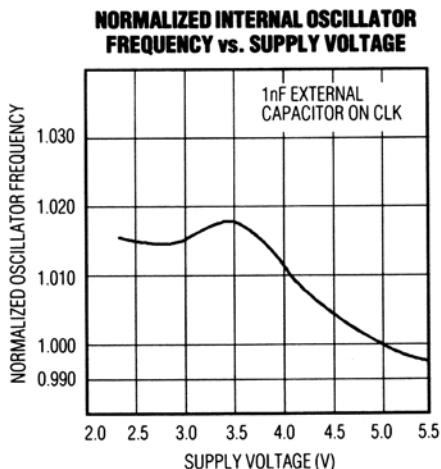
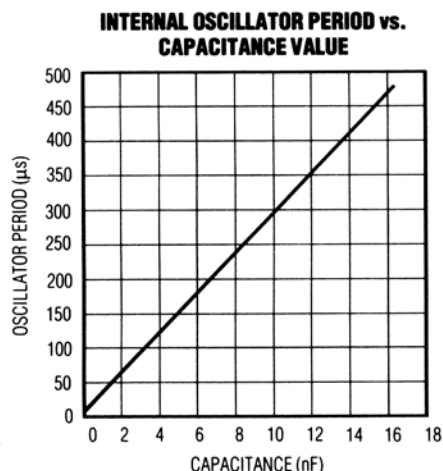

8th-Order, Lowpass, Switched-Capacitor Filters

Typical Operating Characteristics (continued)

($V_+ = 5V$, $V_- = -5V$, $T_A = +25^\circ C$, $f_{CLK} = 100kHz$ (MAX291/MAX292) or $f_{CLK} = 50kHz$ (MAX295/MAX296), unless otherwise noted.)

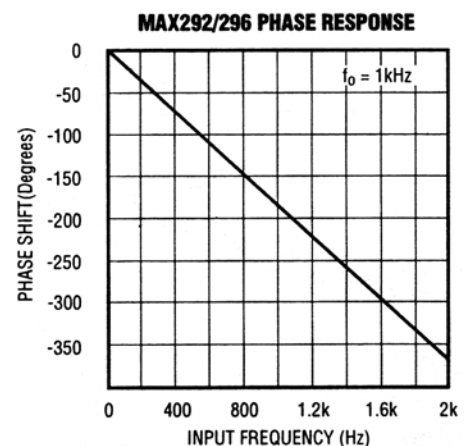
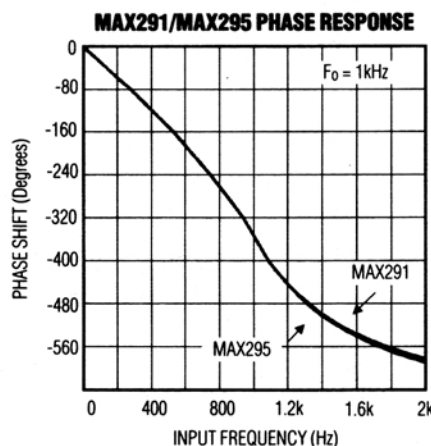
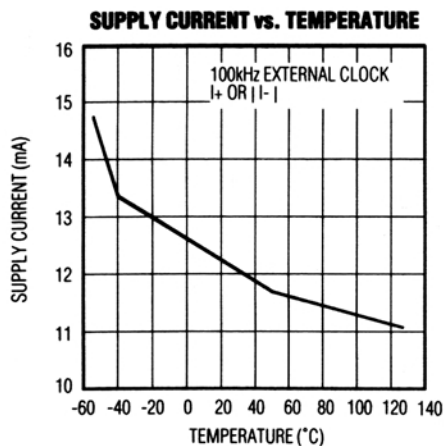
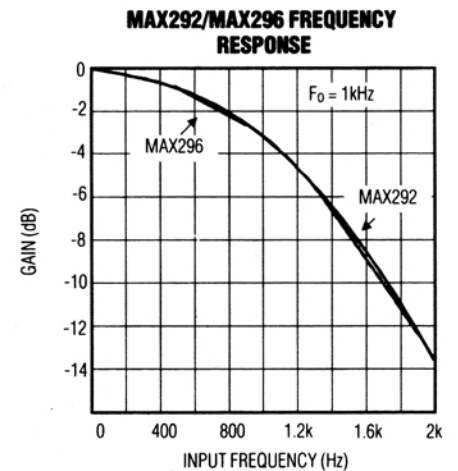
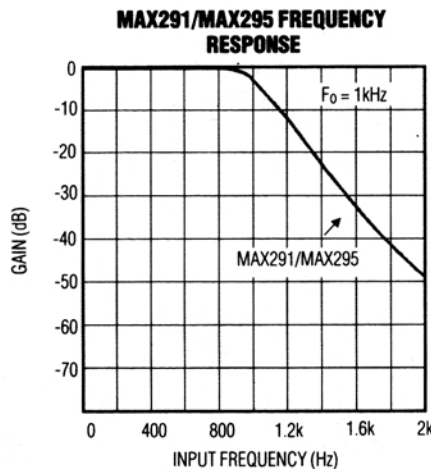
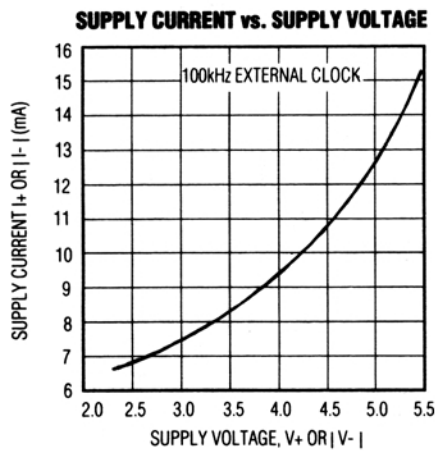
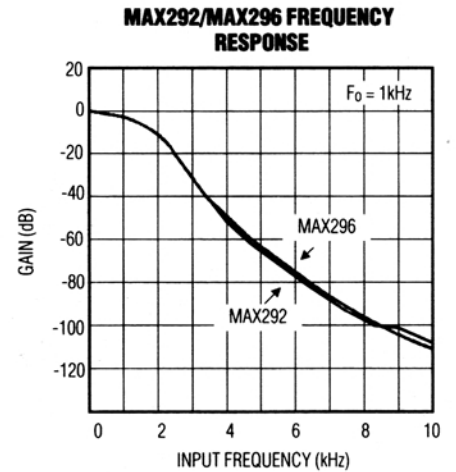
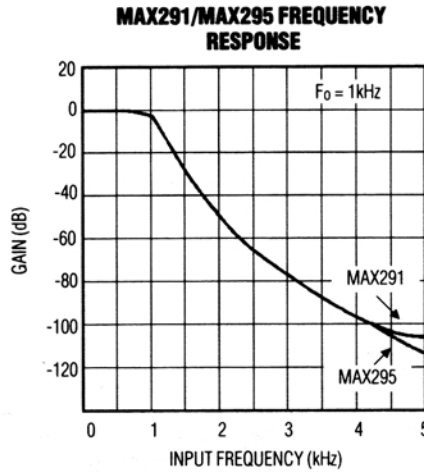
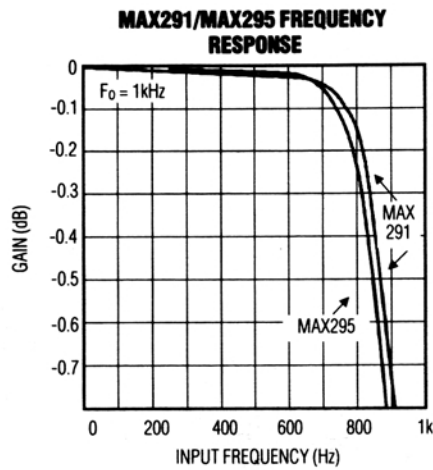

8th-Order, Lowpass, Switched-Capacitor Filters

Typical Operating Characteristics (continued)

($V_+ = 5V$, $V_- = -5V$, $R_{LOAD} = 5k\Omega$, $T_A = +25^\circ C$, unless otherwise noted.)

MAX291/MAX292/MAX295/MAX296

MAX296 LOW-VOLTAGE FREQUENCY RESPONSE

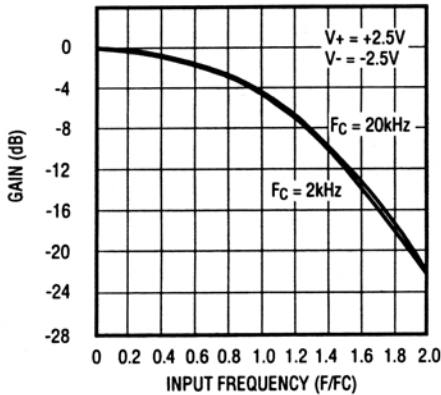

MAX291 LOW-VOLTAGE FREQUENCY RESPONSE

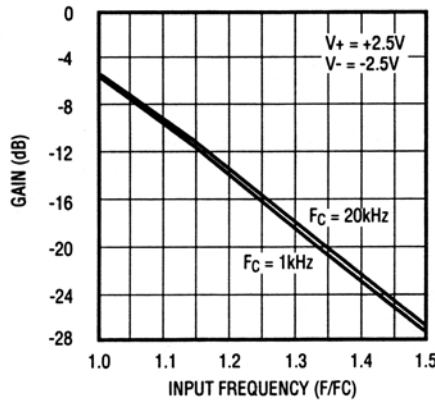

MAX291 THD + NOISE vs. INPUT SIGNAL AMPLITUDE

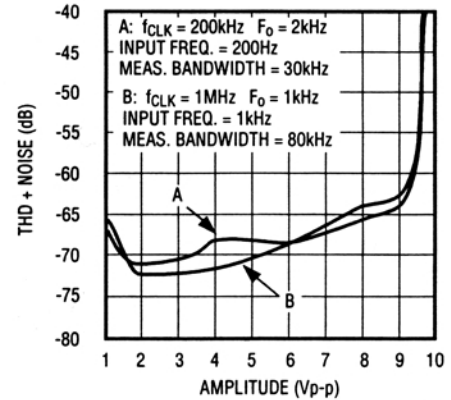

MAX296 LOW-VOLTAGE PHASE RESPONSE

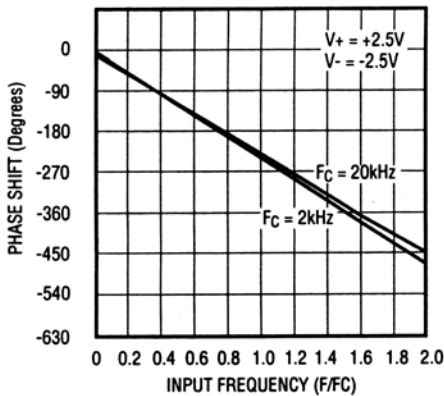

MAX291 LOW-FREQUENCY PHASE RESPONSE

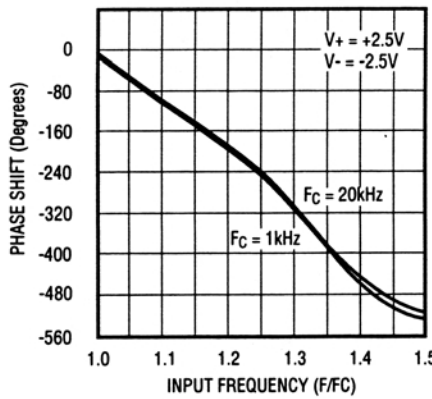

MAX292 THD + NOISE vs. INPUT SIGNAL AMPLITUDE

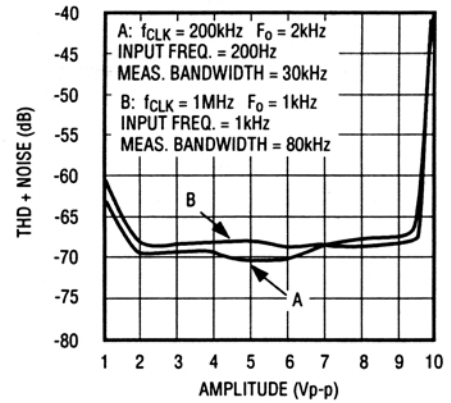

MAX295 THD + NOISE vs. INPUT SIGNAL AMPLITUDE

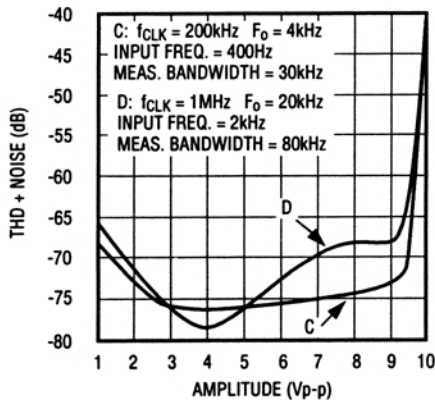

MAX296 THD + NOISE vs. INPUT SIGNAL AMPLITUDE

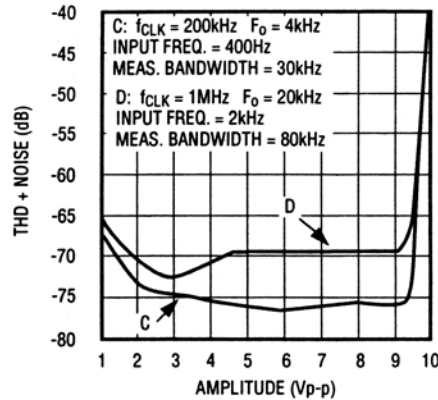

8th-Order, Lowpass, Switched-Capacitor Filters

Pin Description

8-PIN	16-PIN	NAME	FUNCTION
	1, 2, 7, 8, 9, 10, 15, 16	N.C.	No Connect
1	3	CLK	Clock Input. Use internal or external clock.
2	4	V-	Negative Supply pin. Dual supplies: -2.375V to -5.500V. Single supplies: V- = 0V.
3	5	OP OUT	Uncommitted Op-Amp Output
4	6	OP IN-	Inverting Input to the uncommitted op amp. The noninverting op amp is internally tied to ground.
5	11	OUT	Filter Output
6	12	GND	Ground. In single-supply operation, GND must be biased to the mid-supply voltage level.
7	13	V+	Positive Supply pin. Dual supplies: +2.375V to +5.500V. Single supplies: +4.75V to +11.0V.
8	14	IN	Filter Input

Detailed Description

Lowpass Butterworth filters such as the MAX291/MAX295 provide maximally flat passband response, making them ideal for instrumentation applications that require minimum deviation from the DC gain throughout the passband.

Lowpass Bessel filters such as the MAX292/MAX296 delay all frequency components equally, preserving the shape of step inputs, subject to the attenuation of the higher frequencies. They also settle faster than Butterworth filters. Faster settling can be important in applications that use a multiplexer (mux) to select one signal to be sent to an analog-to-digital converter (ADC)—an anti-aliasing filter placed between the mux and the ADC must settle quickly after a new channel is selected by the mux.

The difference in the filters' responses can be observed when a 3kHz square wave, is applied to the filter input (Figure 1, trace A). With the filter cutoff frequencies set at 10kHz, trace C shows the MAX291/MAX295 Butterworth filter response and trace B shows the MAX292/MAX296 Bessel filter response. Since the MAX292/MAX296 have a linear phase response in the passband, all frequency components are delayed equally, which preserves the square wave. The filters attenuate higher frequencies of the input square wave, giving rise to the rounded edges at the output. The MAX291/MAX295 delay different frequency components by varying times, causing the overshoot and ringing shown in trace C.

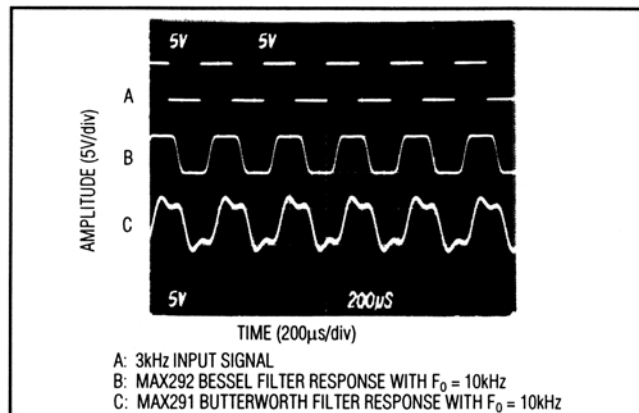

Figure 1. Bessel vs. Butterworth Filter Responses

The MAX291/MAX295 give more attenuation outside the passband. The phase and frequency response curves in the *Typical Operating Characteristics* reveal the differences between the two types of filters.

MAX291/MAX292/MAX295/MAX296 phase shift and gain do not vary significantly from part to part. Typical phase shift and gain differences are less than 0.5% at the corner frequency (F_c).

Corner Frequency and Filter Attenuation

The MAX291/MAX292 operate with a 100:1 clock to corner frequency ratio and a 25kHz maximum corner frequency, where corner frequency is defined as the point where the filter output is 3dB below the filter's DC gain. The MAX295/MAX296 operate with a 50:1 clock to corner frequency ratio with a 50kHz maximum corner frequency. The 8 poles provide 48dB of attenuation per octave.

Background Information

Most switched-capacitor filters are designed with biquadratic sections. Each section implements two filtering poles, and the sections can be cascaded to produce higher-order filters. The advantage to this approach is ease of design. However, this type of design can display poor sensitivity if any section's Q is high.

An alternative approach is to emulate a passive network using switched-capacitor integrators with summing and scaling. The passive network can be synthesized using CAD programs, or can be found in many filter books. Figure 2 shows the basic ladder filter structure.

A switched-capacitor filter that emulates a passive ladder filter retains many of its advantages. The filter's component sensitivity is low when compared to a cascaded biquad design because each component affects the entire filter shape, not just one pole pair. That is, a mismatched component in a biquad design will have a concentrated

8th-Order, Lowpass, Switched-Capacitor Filters

MAX291/MAX292/MAX295/MAX296

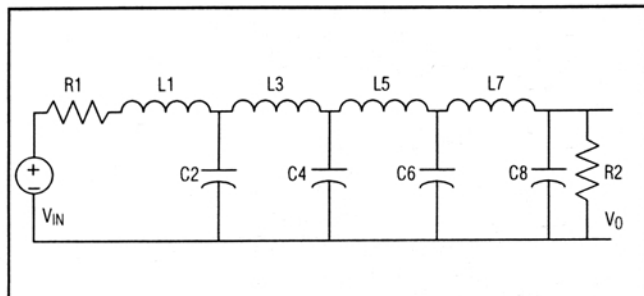

Figure 2. 8th-Order Ladder Filter Network

error on its respective poles, while the same mismatch in a ladder filter design will spread its error over all poles.

The MAX291/MAX292/MAX295/MAX296 input impedance is effectively that of a switched-capacitor resistor (see equation below, and Table 1), and it is inversely proportional to frequency. The input impedance values determined below represent average input impedance, since the input current is not continuous. The input current flows in a series of pulses that charge the input capacitor every time the appropriate switch is closed. A good rule of thumb is that the driver's input source resistance should be less than 10% of the filter's input impedance. The input impedance of the filter can be estimated using the following formula:

$$Z = 1 / (f_{CLK} * C)$$

where: f_{CLK} = Clock Frequency

The input impedance for various clock frequencies is given below:

Table 1. Input Impedance for Various Clock Frequencies

PART	C (pF)	10kHz Ω	100kHz Ω	1000kHz Ω
MAX291	2.24	44.6M	4.46M	446k
MAX292	3.28	30.5M	3.05M	305k
MAX295	4.47	22.4M	2.24M	224k
MAX296	4.22	23.7M	2.37M	237k

Clock-Signal Requirements

The MAX291/MAX292/MAX295/MAX296 maximum recommended clock frequency is 2.5MHz, producing a cutoff frequency of 25kHz for the MAX291/MAX292 and 50kHz for the MAX295/MAX296. The CLK pin can be driven by an external clock or by the internal oscillator with an external capacitor. For external clock applications, the clock circuitry has been designed to interface with +5V CMOS logic. Drive the CLK pin with a CMOS gate powered from 0V and +5V when using either a single +5V supply or dual +5V supplies. The MAX291/MAX292/MAX295/MAX296 supply current increases slightly (<3%) with increasing

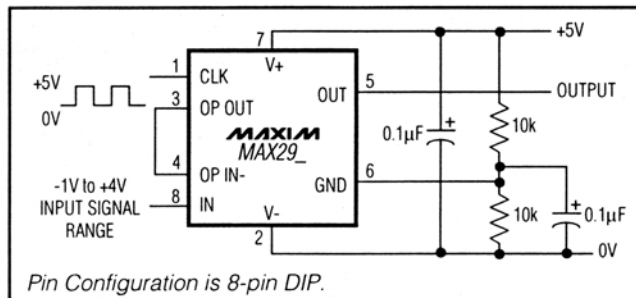

Figure 3. +5V Single-Supply Operation

clock frequency over the clock range 100kHz to 1MHz. Varying the rate of an external clock will dynamically adjust the corner frequency of the filter.

Ideally, the MAX291/MAX292/MAX295/MAX296 should be clocked symmetrically (50% duty cycle). MAX291/MAX292/MAX295/MAX296 can be operated with clock asymmetry of up to 60/40% (or 40/60%) if the clock remains HIGH and LOW for at least 200ns. For example, if the part has a maximum clock rate of 2.5MHz, then the clock should be high for at least 200ns, and low for at least 200ns.

When using the internal oscillator, the capacitance (C_{OSC}) on the CLK pin determines the oscillator frequency:

$$f_{OSC} \text{ (kHz)} \approx \frac{10^5}{3C_{OSC} \text{ (pF)}}$$

The stray capacitance at CLK should be minimized because it will affect the internal oscillator frequency.

Application Information

Power Supplies

The MAX291/MAX292/MAX295/MAX296 operate from either dual or single power supplies. The dual-supply voltage range is +2.375V to +5.500V. The $\pm 2.5V$ dual supply is equivalent to single-supply operation (Figure 3). Minor performance degradation could occur due to the external resistor divider network, where the GND pin is biased to mid-supply.

Input Signal Range

The ideal input signal range is determined by observing at what voltage level the total harmonic distortion plus noise (THD + Noise) ratio is maximized for a given corner frequency. The *Typical Operating Characteristics* show the MAX291/MAX292/MAX295/MAX296 THD + Noise response as the input signal's peak-to-peak amplitude is varied.

Uncommitted Op Amp

The uncommitted op amp has its noninverting input tied to the GND pin, and can be used to build a 1st- or 2nd-

8th-Order, Lowpass, Switched-Capacitor Filters

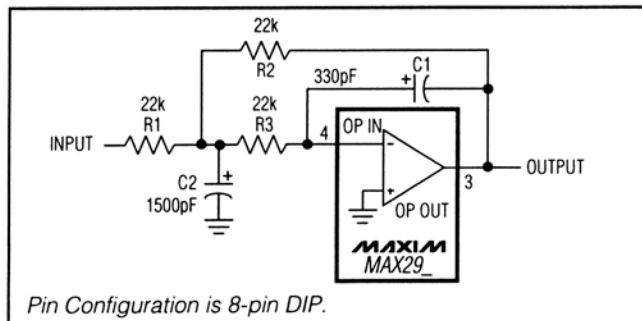

Figure 4. Uncommitted Op Amp Configured as a 2nd-Order Butterworth Lowpass Filter ($F_o = 10\text{kHz}$)

order continuous lowpass filter. This filter is convenient for anti-aliasing applications, or for clock noise attenuation at the switched-capacitor filter's output. Figure 4 shows a 2nd-order lowpass Butterworth filter built using the uncommitted op amp with a 10kHz corner frequency. This filter's input resistance of 22k satisfies the minimum load requirements of the switched-capacitor filter.

The uncommitted Op Amp (with a 2MHz gain bandwidth product) can alternatively be used at the input of the switched-capacitor filter to help reduce any possible clock ripple feedthrough to the output.

DAC Post-Filtering

When using the MAX291/MAX292/MAX295/MAX296 for DAC post-filtering, synchronize the DAC and the filter clocks. If clocks are not synchronized, beat frequencies will alias into the desired passband. The DAC's clock should be generated by dividing down the switched-capacitor filter's clock.

Harmonic Distortion

Harmonic distortion arises from nonlinearities within the filters. These nonlinearities generate harmonics when a pure sine wave is applied to the filter input. Table 2 lists typical harmonic distortion values for the MAX291/MAX292/MAX295/MAX296 with a 1kHz 5Vp-p sine-wave input signal, a 1 MHz clock frequency, and a 5kΩ load.

Table 2. Typical Harmonic Distortion (dB)

		Harmonic			
		2nd	3rd	4th	5th
Filter	MAX291	-72	-78	-83	-89
	MAX292	-71	-82	-82	-88
	MAX295	-93	-86	-92	-97
	MAX296	-71	-89	-96	-96

Ordering Information (continued)

PART	TEMP. RANGE	PIN-PACKAGE
MAX295CPA	0°C to +70°C	8 Plastic DIP
MAX295CWE	0°C to +70°C	16 Wide SO
MAX295C/D	0°C to +70°C	Dice*
MAX295EPA	-40°C to +85°C	8 Plastic DIP
MAX295EWE	-40°C to +85°C	16 Wide SO
MAX295MJA	-55°C to +125°C	8 CERDIP**
MAX296CPA	0°C to +70°C	8 Plastic DIP
MAX296CWE	0°C to +70°C	16 Wide SO
MAX296C/D	0°C to +70°C	Dice*
MAX296EPA	-40°C to +85°C	8 Plastic DIP
MAX296EWE	-40°C to +85°C	16 Wide SO
MAX296MJA	-55°C to +125°C	8 CERDIP**

* Contact factory for dice specifications.

** Contact factory for availability and processing to MIL-STD-883.

Pin Configurations (continued)

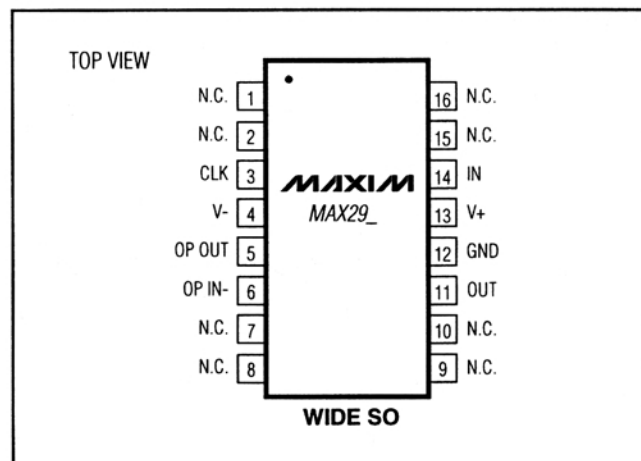

Maxim cannot assume responsibility for use of any circuitry other than circuitry entirely embodied in a Maxim product. No circuit patent licenses are implied. Maxim reserves the right to change the circuitry and specifications without notice at any time.